

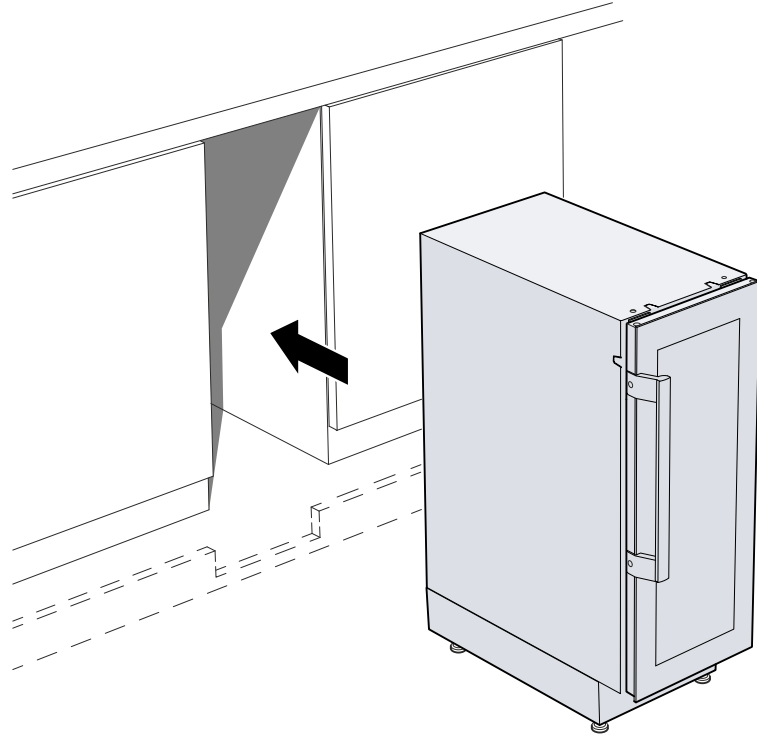

9001542637 (040206)



mm



T25

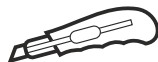
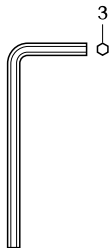
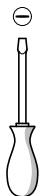
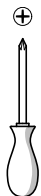
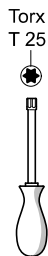
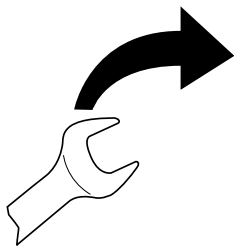
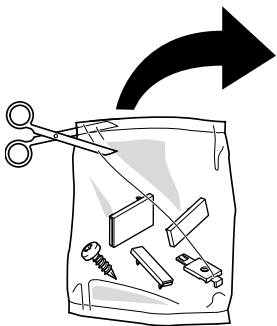
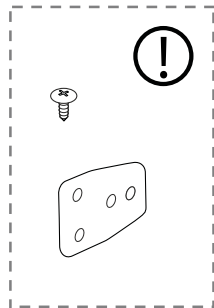
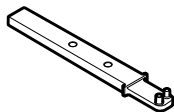

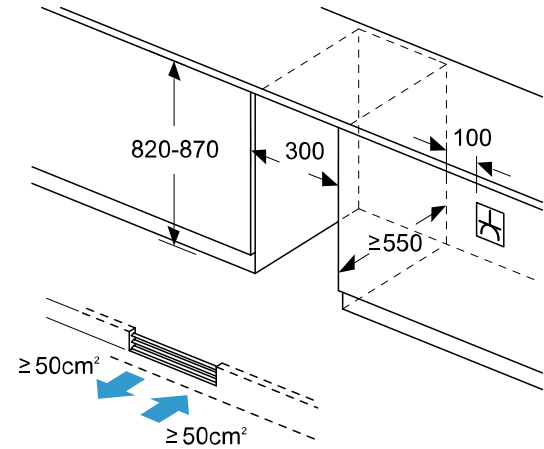
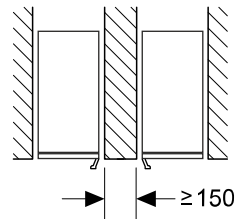
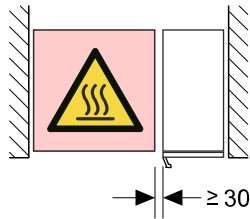
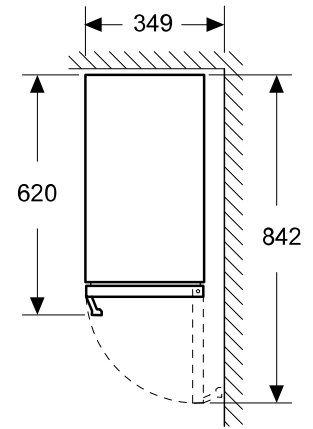
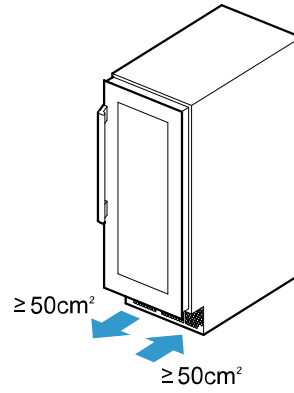
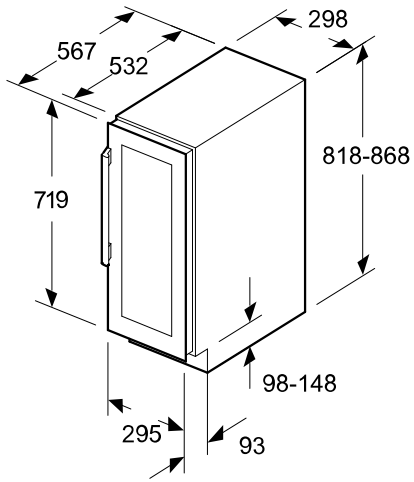

T25

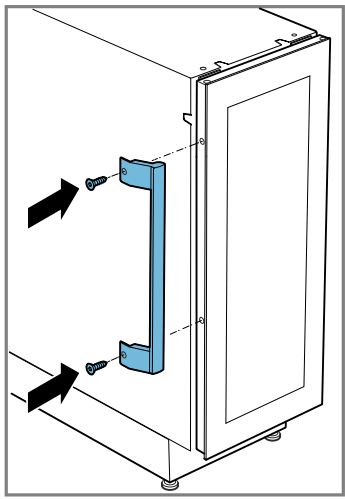
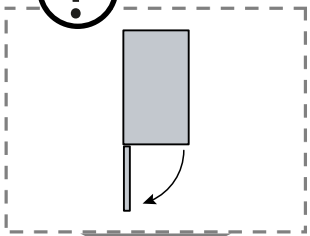
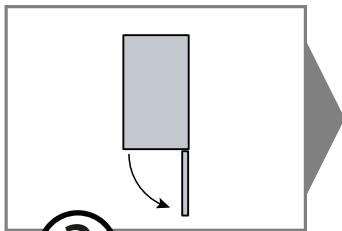
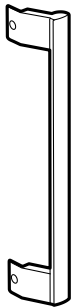

Torx
T 25

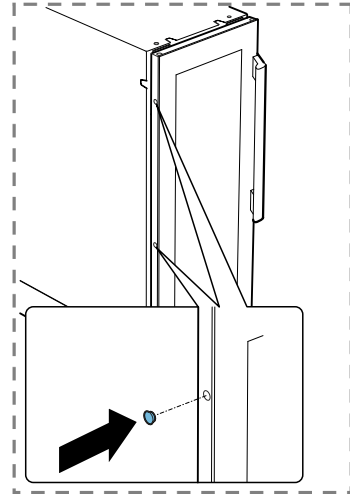
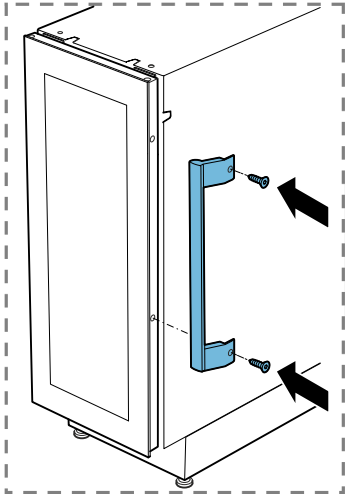
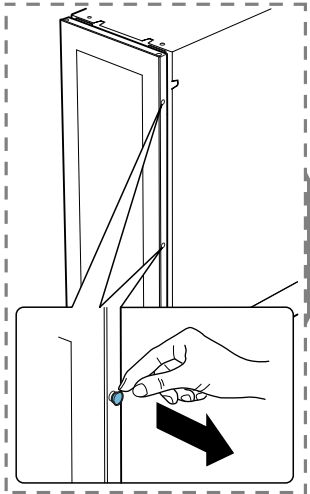

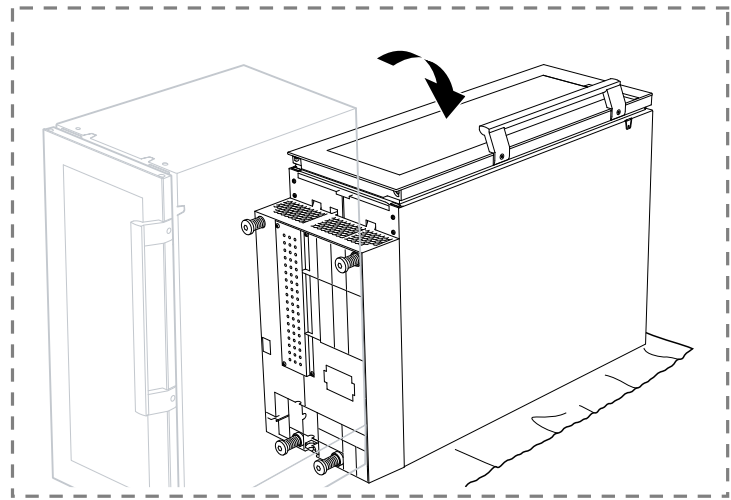
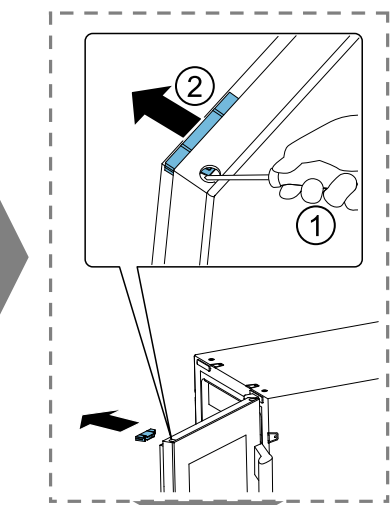
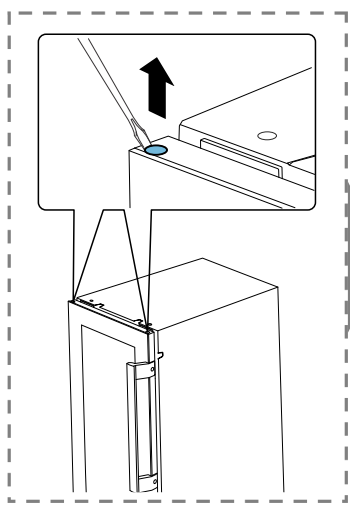
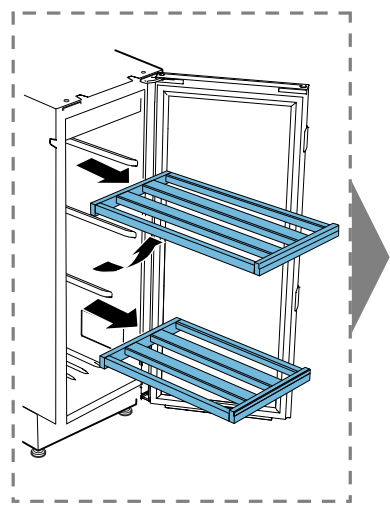
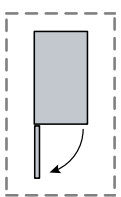

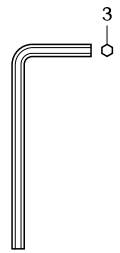
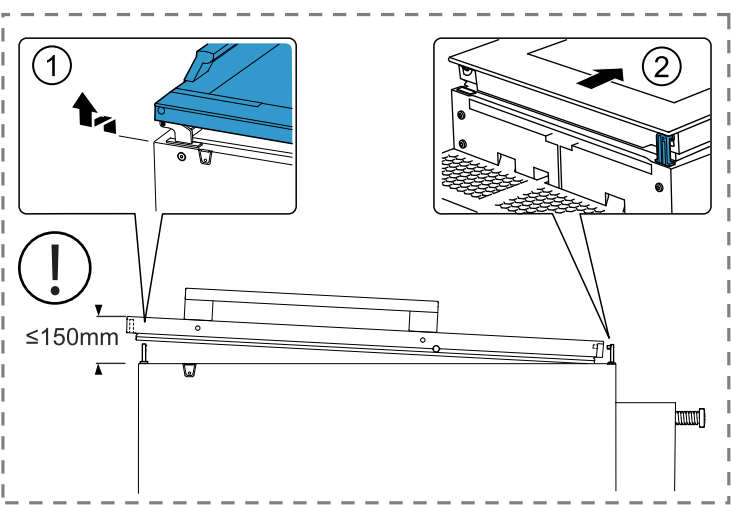
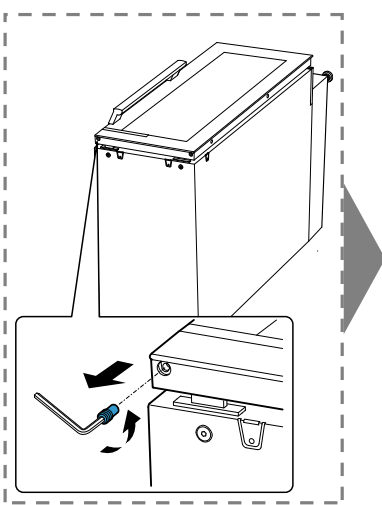
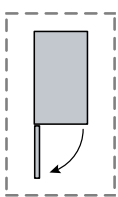

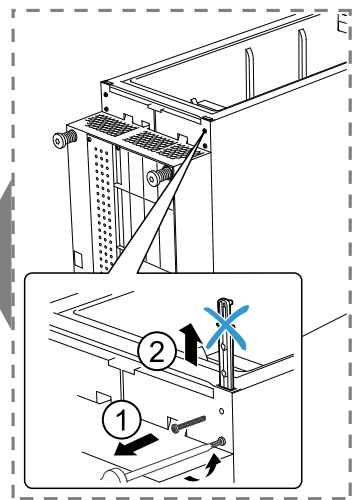
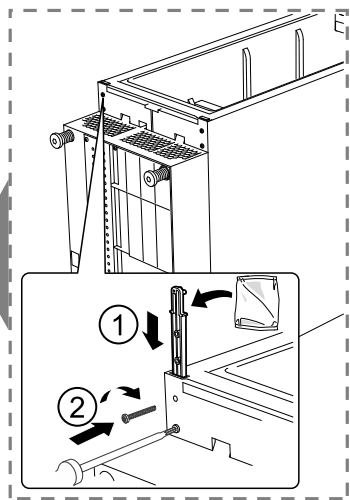
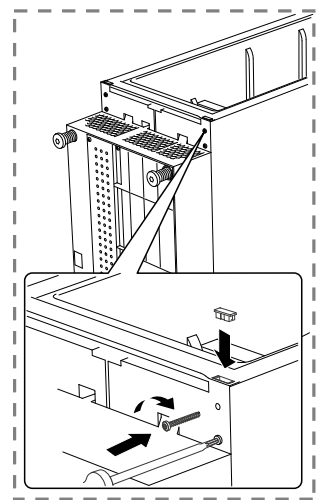
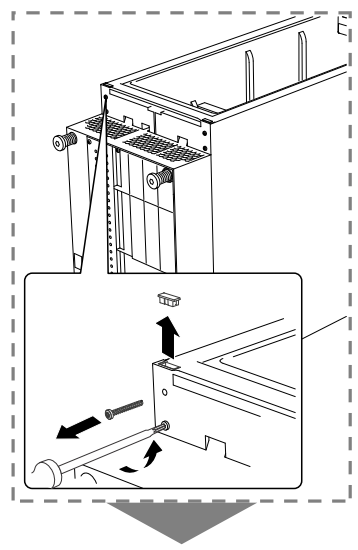
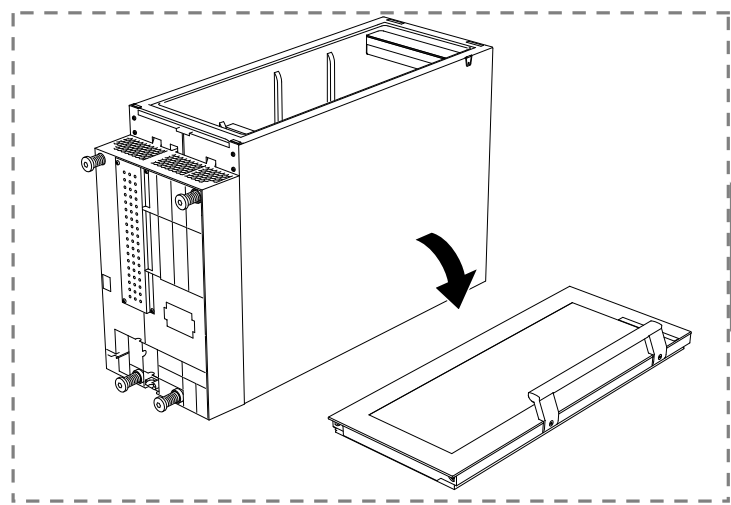
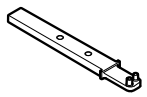
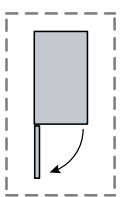

Torx
T 20

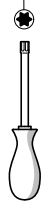

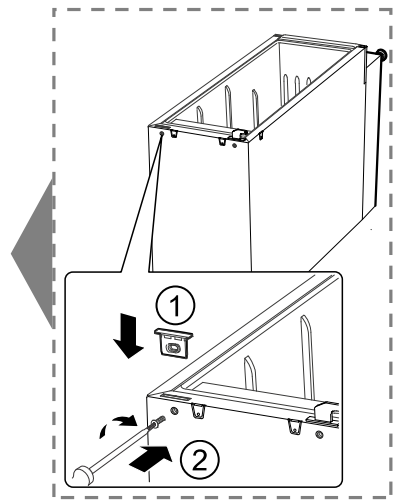
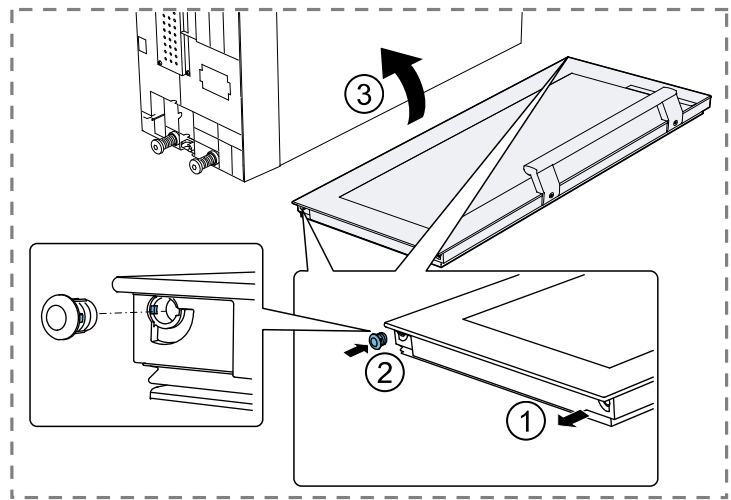
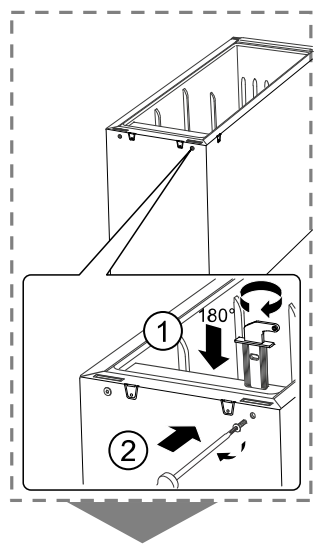
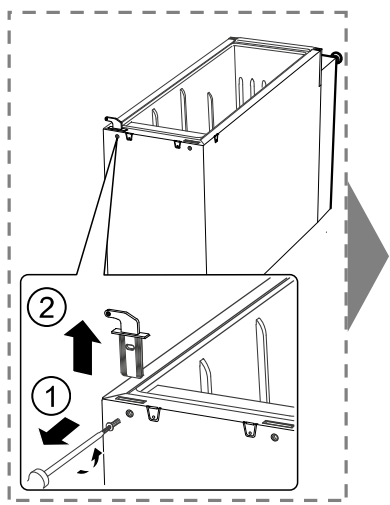
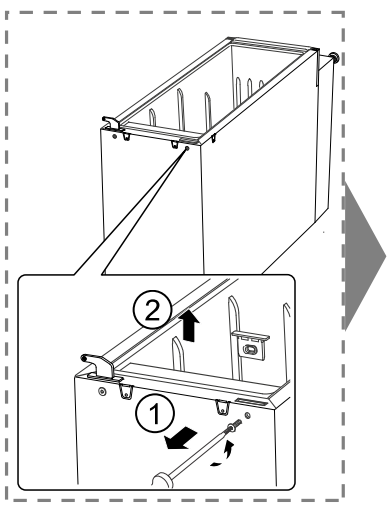
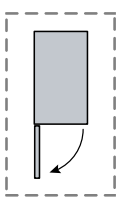

Torx
T 25



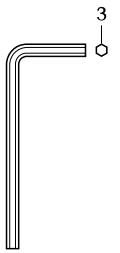
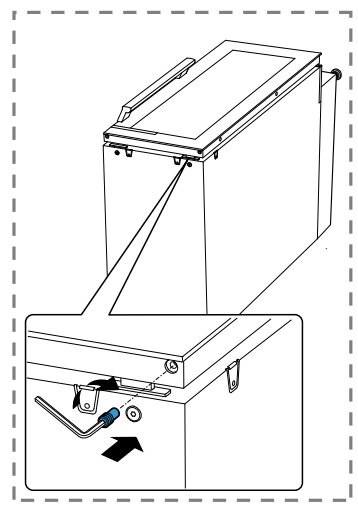
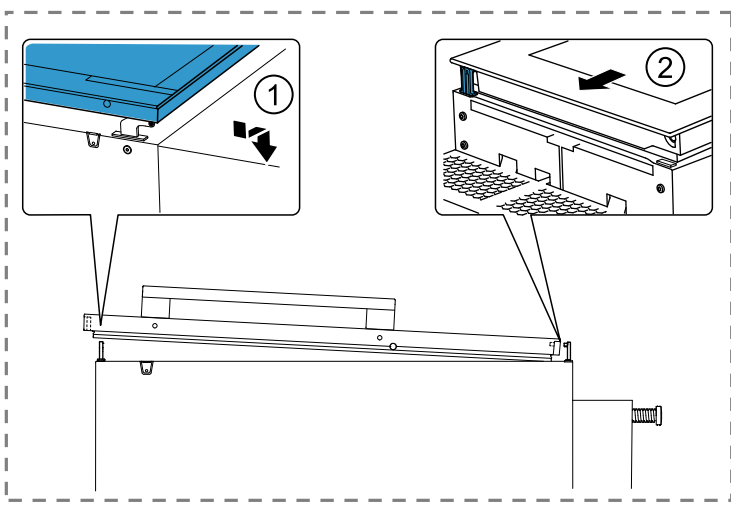
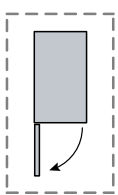

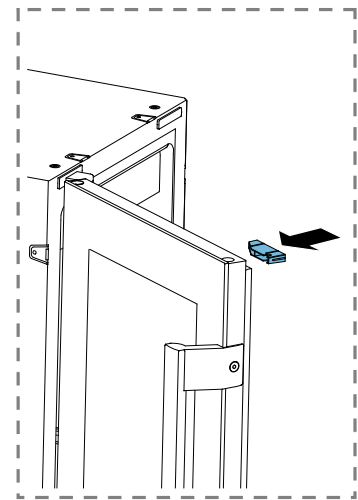
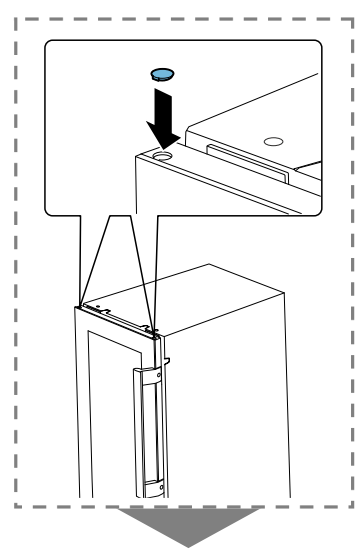
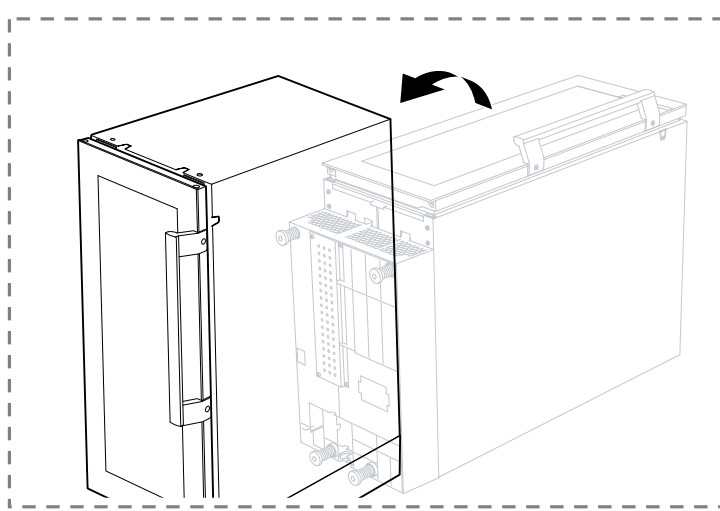
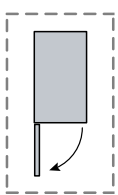

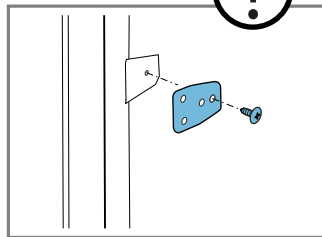
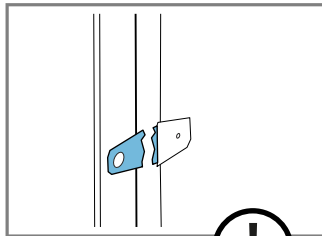
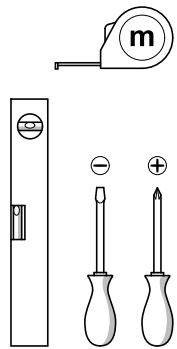
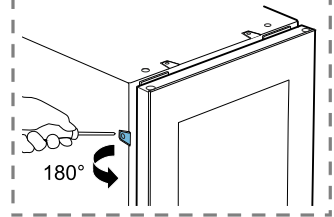
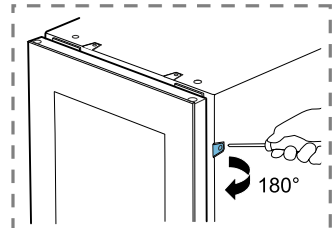
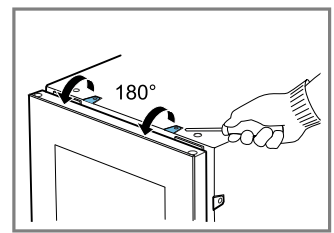
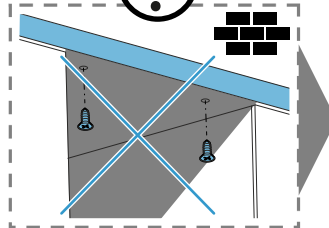
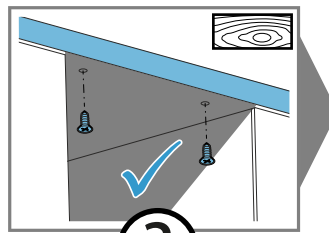
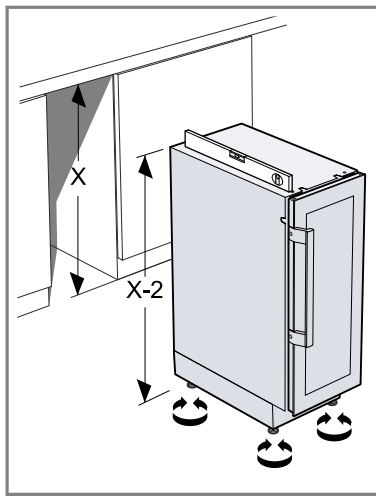
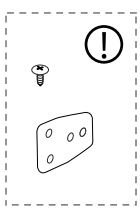

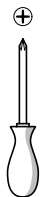
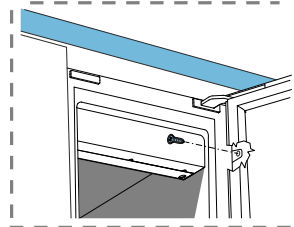
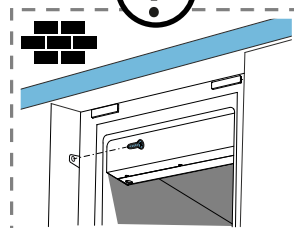
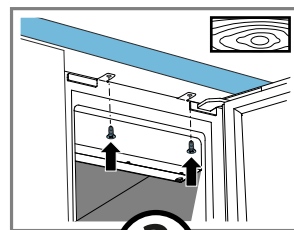
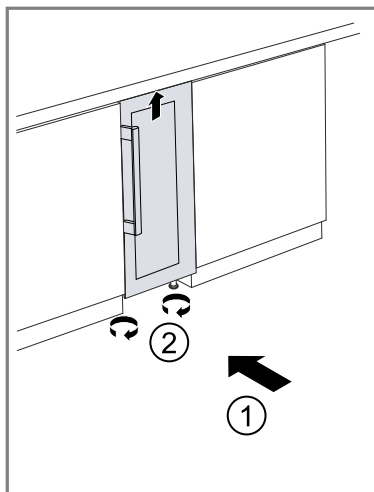
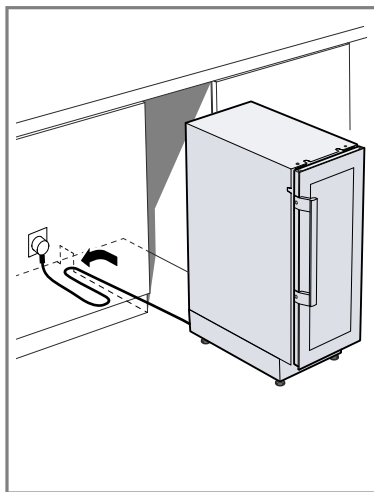

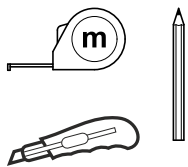
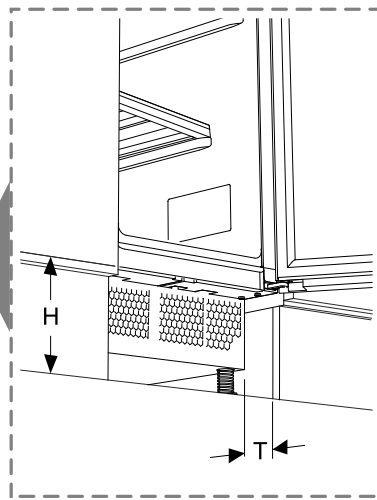
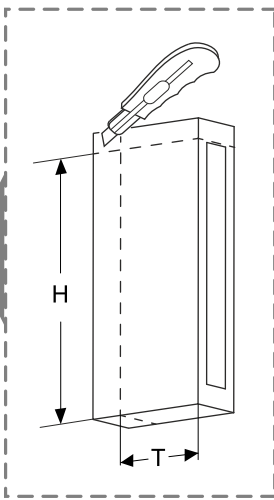
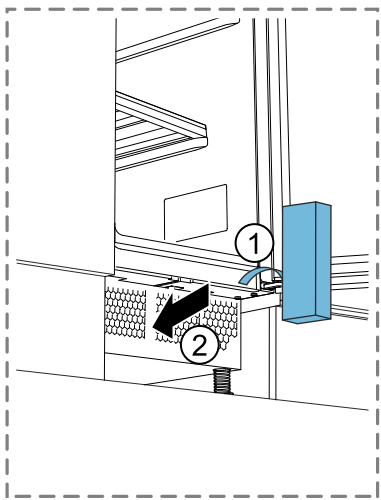
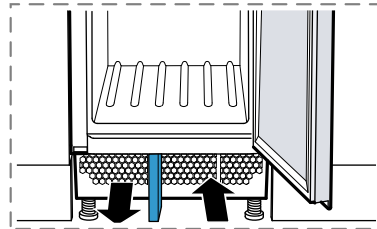
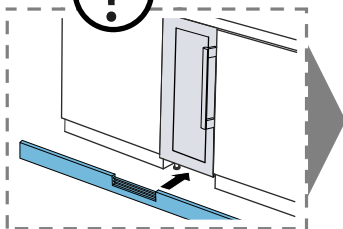
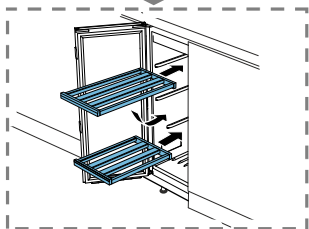
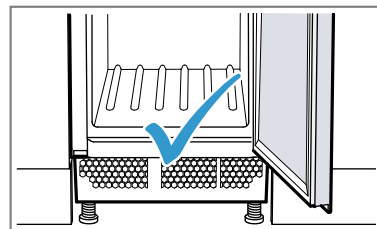
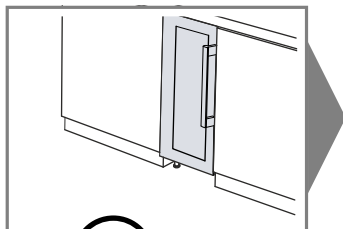
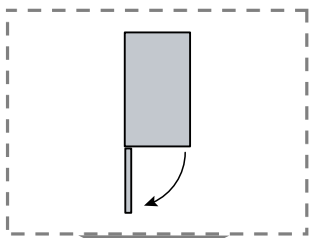



A series of horizontal lines for writing, starting from a vertical margin line on the left and extending across the page.

